

PZ - 90.02 coordinates

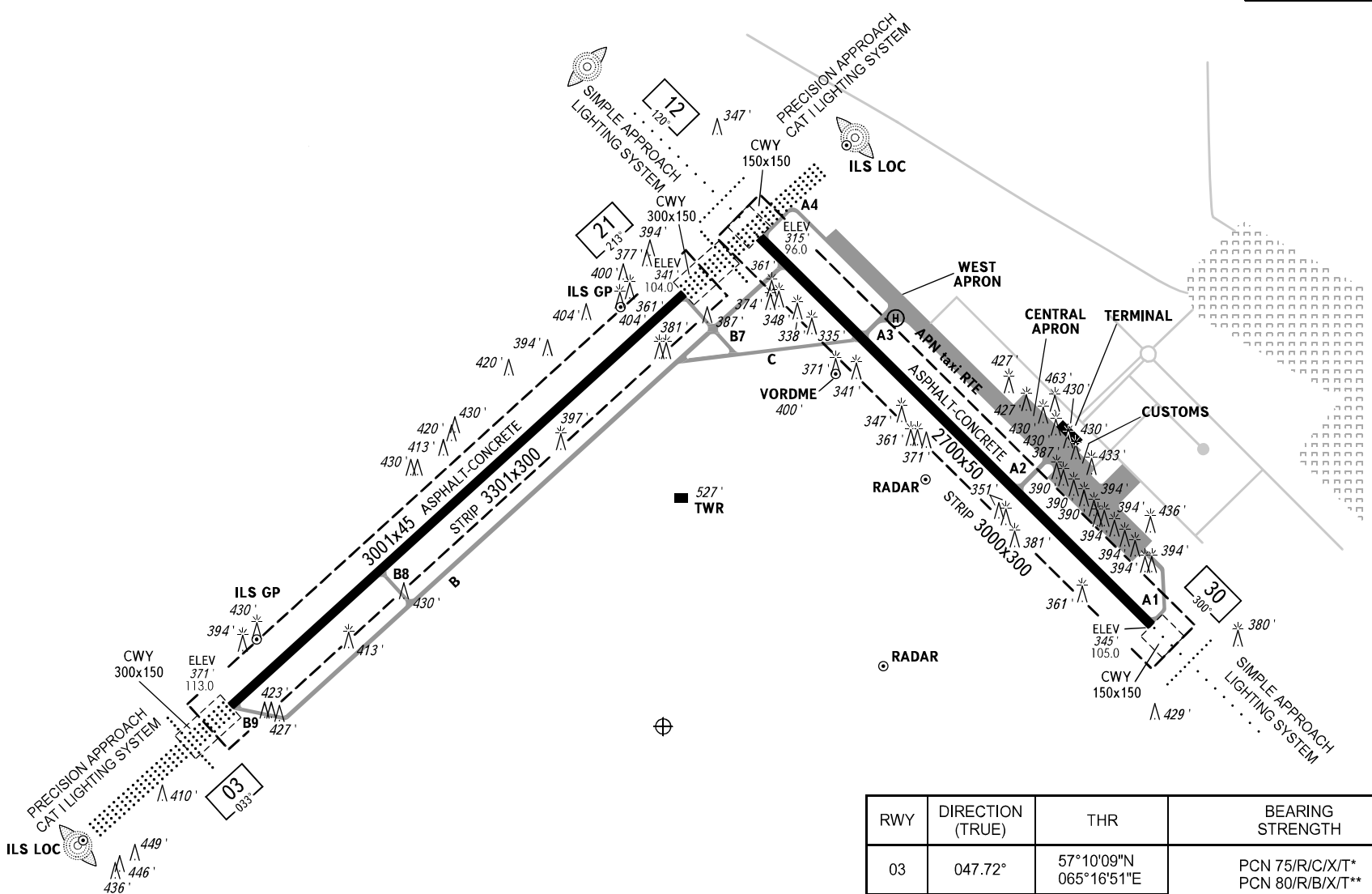

BEARINGS ARE MAGNETIC
ELEVATIONS IN FEET AND METRES
DIMENSIONS IN METRES

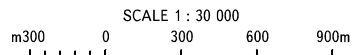

RWY	DIRECTION (TRUE)	THR	BEARING STRENGTH
03	047.72°	57°10'09"N 065°16'51"E	PCN 75/R/C/X/T* PCN 80/R/B/X/T**
21	227.75°	57°11'14"N 065°19'04"E	* from 01 APR to 19 NOV ** from 20 NOV to 31 MAR
12	134.72°	57°11'23"N 065°19'26"E	PCN 44/R/C/X/T* PCN 44/R/B/X/T**
30	314.75°	57°10'22"N 065°21'20"E	* from 01 APR to 19 NOV ** from 20 NOV to 31 MAR

MARKING AIDS RWY 03 / 21 AND EXIT TWY

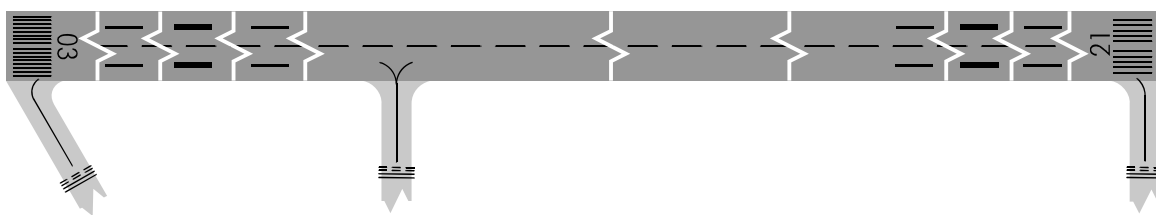

LIGHTING AIDS RWY 03 / 21 AND EXIT TWY

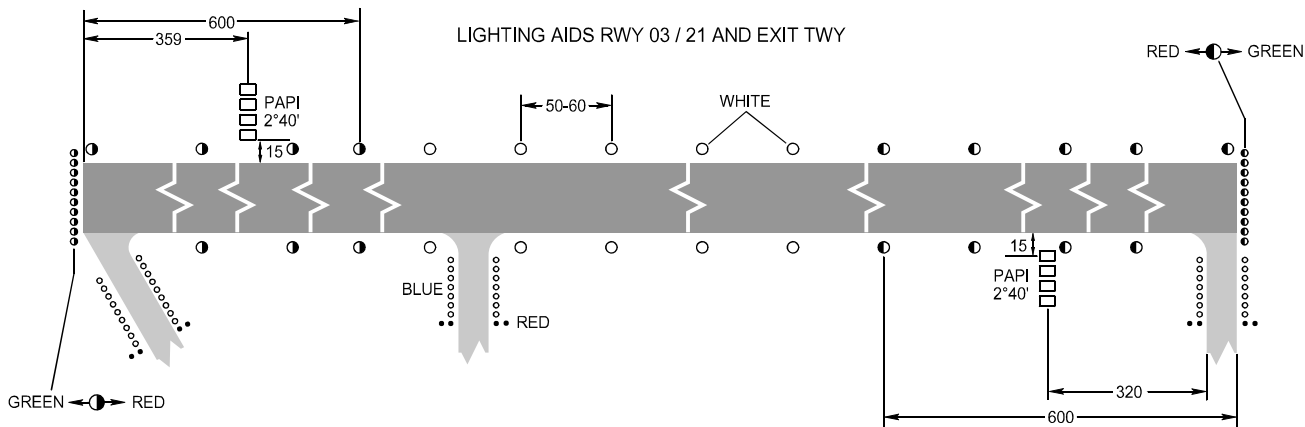

MARKING AIDS RWY 12 / 30 AND EXIT TWY

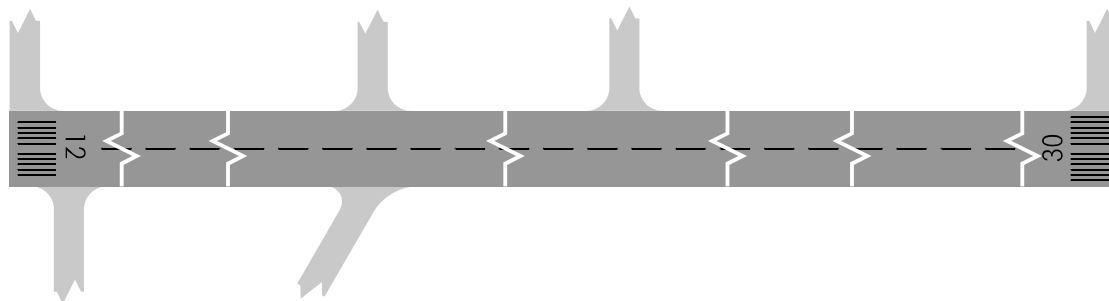

LIGHTING AIDS RWY 12 / 30 AND EXIT TWY

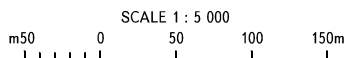
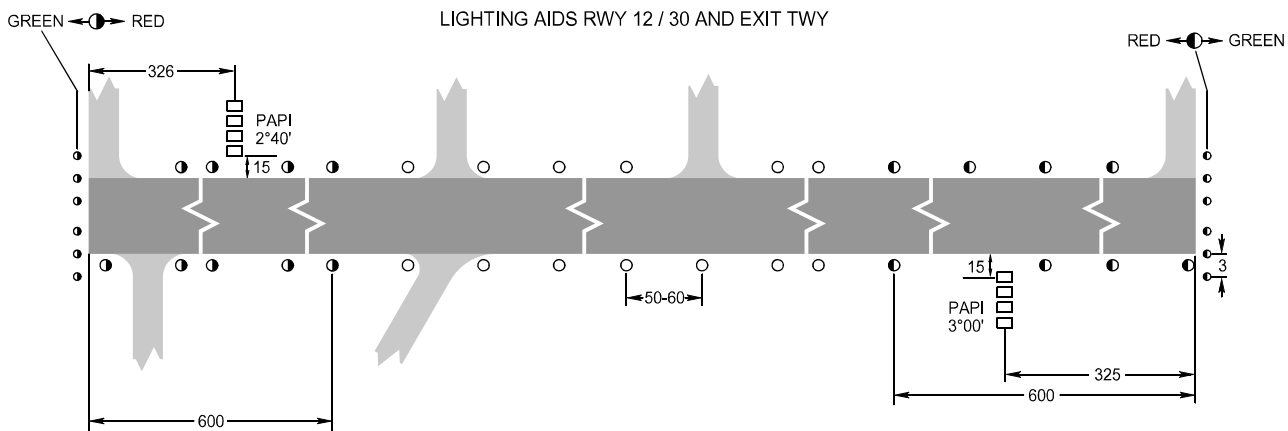

DIMENSIONS IN METRES

CHANGE: New chart